

**Spot-Check Monitor**

**User Instruction Manual**

This manual is written for the PC-303 Spot-Check Monitor.

The manual describes, in accordance with the Spot-Check Monitor's features and requirements, the main structure, functions, specifications, correct methods for transportation, installation, usage, operation, repair, maintenance and storage, etc. as well as the safety procedures to protect both the user and equipment. Refer to the respective chapters for further details.

The manual is published in English and Creative has the ultimate right to explain the Manual.

For the user's convenience, we share the latest version analysis software of the Spot-Check Monitor on our website, go to [www.creative-sz.com/software/PC software](http://www.creative-sz.com/software/PC_software) to download the latest version of the data management software. Please contact the manufacturer or your local distributor if there are any issues downloading the software.

Version of This User Manual: Ver2.3

Product service life: 5 years (no warranty)

Issue Date: November 18, 2021

Manufacturing date: See Label

All rights reserved

Marks in the manual:

 **Caution: Instructions must be followed to avoid causing harm to the user or patient.**

 **Attention: must be followed to avoid causing damage to the Spot-Check monitor.**

 **Note: contains important information and advice about operations and application.**

3502-2600002





## Instructions for use

Dear Customers,

Thank you for purchasing the PC-303 Spot-Check Monitor. Please read the following information before using the device.

These instructions describe the operating procedures which are to be strictly followed, read these instructions carefully before using the Spot-Check Monitor. Failure to follow these instructions can cause monitoring abnormalities, damage to the monitor and personal injury. The manufacturer is NOT responsible for the safety, reliability and performance issues or any monitoring abnormalities, personal injury and equipment damage due to user's negligence of the operation instructions. The manufacturer's warranty service does not cover such faults

### Warnings:

-  **Do NOT use the device under flammable gas conditions or in any environment that may lead to explosion.**
-  **The device and accessories should not be serviced or maintained while the device is in use.**
-  **The doctor or patient is the intended operator.**
-  **Do not modify this equipment without authorization from the manufacturer.**

- The SpO<sub>2</sub>, NIBP, Temperature, and ECG (optional) measurements are the frequently used functions.
- The device is IP22 and is protected against solid foreign objects of 12.5mm or greater, and protected against vertically falling water drops when the enclosure is tilted up to 15.
- Please check the monitor before use to verify that the accessories function safely and correctly.
- If the monitor is connected with other devices, the total leakage current may exceed the limitation and as a result this can cause potential danger to the user.
- Although bio-compatibility tests have been performed on all the applied parts, under exceptional circumstances, allergic patients may have anaphylaxis. Do NOT use the monitor on patients with anaphylaxis.
- All connecting cables and rubber tubes of the applied parts should be kept away from the patient's neck to prevent suffocation.
- As a standard, please only use the components provided by the manufacturer or those that are of the same model and specifications as the accessories.
- If the monitor falls off a surface accidentally, please do NOT operate it before its safety and technical performance have been tested and positive results obtained.
- Do NOT open the device cover without authorization. The cover should only be opened by a qualified service personnel.
- When disposing of the monitor and its accessories, national regulations should be followed. There

are some electromagnetic or inductance circuit designed in the device, use during MRI environment could burns or adversely affect the MRI image or the device's accuracy. So the device is MR unsafe.

- The device and accessories are provided non-sterile.
- The device has no alarm and is intended only for spot-checking.

## Table of contents

CHAPTER 1 OVERVIEW.....	1
1.1 Features.....	1
1.2 Product Name and Model.....	2
1.3 Intended Use.....	2
1.4 Impact on the Environment and Resources.....	2
CHAPTER 2 OPERATION INSTRUCTIONS.....	3
2.1 Appearance.....	3
2.1.1 The Front Panel.....	3
2.1.2 The Right and Upper Sides of the Device.....	5
2.2 Installation.....	8
2.2.1 Power Supply.....	8
2.2.2 Starting the Monitor.....	8
2.2.3 Downloading APP software onto smart phones.....	9
2.3 Taking Measurements.....	11
2.3.1 Blood Pressure Measurement....	

2.3.2 SpO <sub>2</sub> Measurement.....	15
2.3.3 Temperature Measurement.....	19
2.3.4 Blood Glucose Measurement (Optional).....	22
2.3.5 ECG Measurement (Optional).....	25
2.4 Blood Pressure Accuracy Check Method.....	29
<b>CHAPTER 3 MONITORING SCREEN DISPLAY.....</b>	<b>33</b>
3.1 Measuring Screen.....	33
3.2 System Setting Screen.....	35
3.3 History Data Review Screen.....	37
3.4 Data Uploading.....	38
<b>CHAPTER 4 TECHNICAL SPECIFICATIONS.....</b>	<b>40</b>
4.1 Blood Pressure Measurement.....	40
4.2 SpO <sub>2</sub> Measurement.....	41
4.3 Pulse Rate Measurement.....	43
4.4 Temperature Measurement.....	43
4.5 Blood Glucose Measurement (Optional).....	43
4.6 ECG Measurement (Optional).....	44
4.7 Others.....	

4.7.1 Operating Environment.....	44
4.7.2 Classification.....	46
CHAPTER 5 TROUBLESHOOTING.....	47
CHAPTER 6 ERROR MESSAGE INTERPRETING.....	48
CHAPTER 7 PACKING LIST.....	49
CHAPTER 8 MAINTENANCE AND SERVICE.....	51
8.1 Technical Maintenance.....	51
8.1.1 Daily Examination.....	51
8.1.2 Routine Maintenance.....	51
8.1.3 Battery Maintenance.....	52
8.2 Cleaning and Disinfection of the Main Unit.....	53
8.3 Cleaning and Disinfection of Accessories .....	54
8.4 Storage.....	55
8.5 Transportation.....	56



## CHAPTER 1 OVERVIEW

### 1.1 Features

- ✧ Small in size, light in weight, easy to carry and operate;
- ✧ Clear and large numeric display, segmented LCD panel, real-time clock display; Accurate blood pressure measurements can be activated or canceled by one shortcut button;
- ✧ Unique oximetry technique ensures quick and accurate SpO<sub>2</sub> & pulse rate measurements by smart sensors;
- ✧ Smart infrared temperature probe ensures quick and accurate measurements of body temperature;
- ✧ Blood pressure, oxygen saturation, pulse rate and temperature can be measured simultaneously;
- ✧ Blood Glucose meter option can be connected to the device ;
- ✧ Data storage with recall, up to 999 groups of records can be stored and recognised by patient ID.
- ✧ Power management with power saving mode, auto power off and low battery indicator;
- ✧ Data upload to PC by USB cable and real-time data transmission to smart phones by wireless connections.

## 1.2 Product Name and Model

Name: Spot-Check Monitor

Model and Configuration:

Model	Configuration					LCD display
	NIBP	SpO <sub>2</sub>	Pulse Rate	Temperature	ECG	
PC-303	√	√	√	√	√	√

NOTE: 1. Spot-Check Monitor can configure with ECG and blood glucose function, details see the User Manual for Easy ECG Monitor and Super Check 1 Glucose Meter respectively.

2. "√" means function available, and "--" means function unavailable.

## 1.3 Intended Use

The Spot-Check Monitor is a device designed for spot-checking the user's physiological parameters, such as non-invasive blood pressure (NIBP), functional oxygen saturation (SpO<sub>2</sub>), pulse rate (PR), and body temperature (TEMP). Additionally, the device can take measurements from the Blood Glucose Meter function, and ECG data from the Easy ECG Monitor (both Blood Glucose Meter and Easy ECG Monitor are certified separately). This device is applicable for adult and pediatric (age ≥3 years old) use in clinical institutions and has no conditions or factors of contraindication.

## 1.4 Impact on the Environment and Resources

Low

## CHAPTER 2 OPERATION INSTRUCTIONS



### 2.1 Appearance

#### 2.1.1 The Front Panel







Figure 2.1

**Description:**

1/2. / up/down key: on the setup display screen, a short press will change the parameter value step by step, press and hold to change the parameter values quickly; on the review display screen, short press to review the history data records one by one, press and hold to recall the history data records quickly.

3.  Memory key: on the measurement display screen, press and hold the key (for 3 seconds) to enter into the review display screen; once the review display screen, a short press will recall the history data records.

On the setup display screen, all parameters can be set in anticlockwise order by pressing and holding the "" key, similarly, a short press of the "" key will set the parameters in clockwise order.

4.  Menu key: on the measurement display screen, press and hold the menu key to enter the setup screen; on the setup or review display screen, press and hold the "" key to go back to the measurement display screen.

5.  Start/cancel button: on the measurement display screen, a short press of this button will activate or cancel the blood pressure measurement.

### 2.1.2 The Right and Upper Sides of the Device

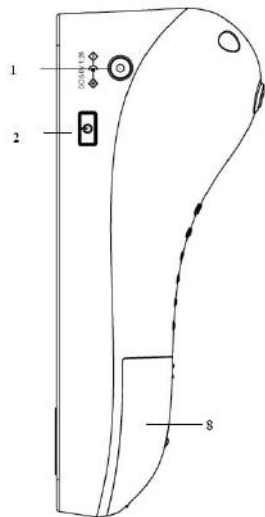

Figure 2.2

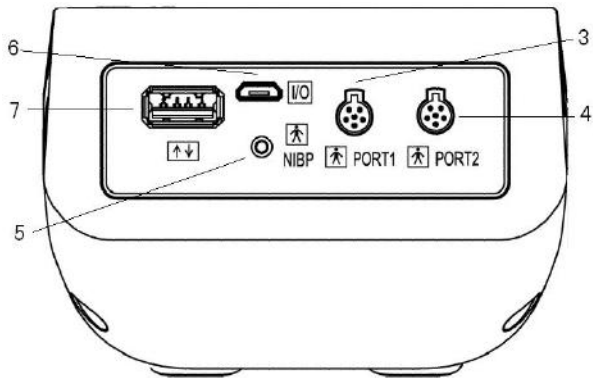





Figure 2.3A

The power switch and external DC power input socket are on the right side of the monitor as shown in figure 2.2.

The signal input/output ports are on the upper side of the monitor as shown in figure 2.3A (for the previous version).

**Description:**

1.  : External DC power input socket.  
DC 5.0V 1.2A
2.  : Power switch: = press and hold to turn the monitor on/off.
- 3/4. **Port 1/Port 2:** Connector to link with the temperature probe or smart SpO<sub>2</sub> probe.
5. **NIBP:** Cuff connector.
6.  : Charge / USB data interface.
7.  : Connector to link with the blood glucose meter.
8. Battery cover.

NOTE: Figure 2.3A is the upper-side-view for the previous version device, and Figure 2.3B is the upper-side-view for the current version device. The difference between the two versions is seen on the

upper-side panel. The previous version device has only 2 "" ports, marked "PORT1" and "PORT2", which are the generic connectors capable of connecting any combination of temperature probe, smart SpO<sub>2</sub> probe or ECG accessory (for example Easy ECG Monitor). However, the current version device has 3

"" ports, marked "SpO<sub>2</sub>", "TEMP" and "ECG" respectively, which can be used only to connect

the corresponding sensors or accessories.

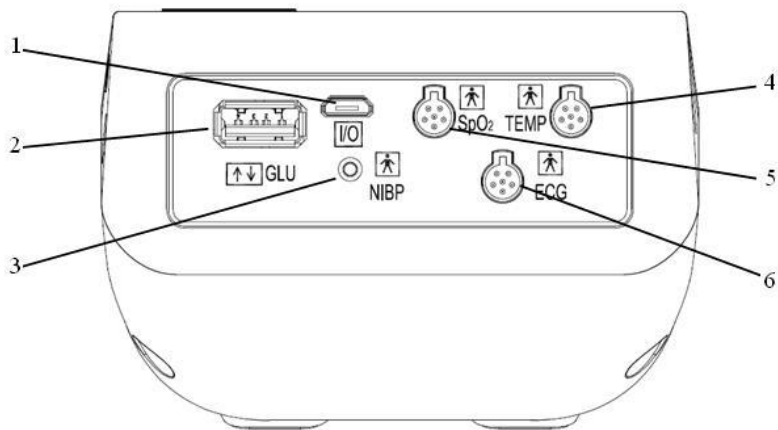



Figure 2.3B Upper-side view

**Description:**

1. : Charge / USB data interface.
2. : Connector to link to the blood glucose meter.
3. NIBP: Cuff connector.
4. TEMP: Temperature probe connector.

5. SpO<sub>2</sub>: Smart SpO<sub>2</sub> probe connector.
6. ECG: Connector to link with ECG accessories.

## 2.2 Installation

### 2.2.1 Power Supply

1. Internal power supply to the built-in battery

When the battery indicator "" displays full grids, the built-in battery is fully charged. When it blinks, the battery voltage is low, and the user should charge the battery by connecting the device to the AC power adapter or a USB power source via USB cable. When the grids of the battery indicator are rolling circularly, the battery is being charged.

2. External power supply from the AC power adapter

Use the AC power adapter provided by the manufacturer. Make sure that the mains power supply is 110-240VAC with 50/60Hz.

3. External power supply from the USB cable

Use the USB data cable with micro-USB connector, connect one end of the data cable to the connector on the device marked "", and the other end to the USB power source with output capacity of 5Vdc/1.2A.

### 2.2.2 Starting the Monitor

By pressing and holding down the switch, the software version will be displayed, after releasing the switch,



the device will enter the measurement display screen automatically. The user can then begin to operate the monitor.

➤ If the monitor fails to start by pressing the switch, please use the external power supply.

### **2.2.3 Downloading APP software onto smart phones**

Terminal devices such as Android smart phones or iOS system (such as iPhone, iPad) can be used to receive data from the Spot-Check Monitor in real-time, store the received data, and also review the stored data. To use this function, download the corresponding APP software onto the smart phone device.

Please follow the procedure to download:

1. Use your phone or pad to scan the QR Code image in Figure 2.4.
2. When successfully scanned, a web link for downloading the APP software will be displayed.
3. Open the web link (open with browser for Android or open in Safari for iOS system ) to download the APP software.
4. Install the software when successfully downloaded.

Note: for iOS users, you can enter the App Store, and enter "Shenzhen Creative" into the search function (if you use an iPad to search, please select "iPhone only" when searching). Once the search results are

listed, select the result with @health icon  , then download the corresponding APP software. Note: .

### Instruction for Measurement

- ☞ Make sure the APP software successfully connects with the Spot-Check Monitor.
- ☞ Refer to the manual of the APP software for more detailed information for operation.



Figure 2.4 QR Code image

## 2.3 Taking Measurements

### 2.3.1 Blood Pressure Measurement

1. Applying the cuff; unfold the cuff and wrap it around the upper arm evenly to the appropriate tightness. The correct cuff position is shown in figure 2.5.

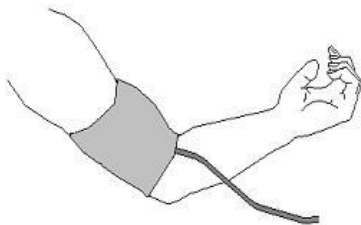

Figure 2.5 Cuff position

2. Connect the hose from the cuff to the connector on the upper-side of the device where marked "NIBP".
3. Press the start/cancel button "⏪" to begin the blood pressure measurement.

### NIBP Measurement Principle

The NIBP measurement is based on oscillation technology. The measurement is started by inflating the cuff by a pump automatically after the cuff pressure is high enough to block the arterial blood flow within the upper arm, then the cuff pressure is deflated slowly, and all the change of cuff pressure in the

deflation process is recorded to calculate blood pressure based on certain algorithm. The device will judge whether the quality of signal is good enough. If the signal is not good enough (such as sudden movement or touch of cuff while measurement), the device will stop deflating or re-inflating, or aborting this measurement and calculation.

### **Safety Instructions for blood pressure measurement**

- Blood pressure measurement is prohibited to those who have severe hemorrhagic tendencies or with sickle cell disease, as partial bleeding may be caused.
- An appropriate cuff should be selected according to the age and arm circumference of the patient. The cuff width should be  $\frac{2}{3}$  of the length of the upper arm. The inflatable part should be long enough to permit wrapping approximately 80% of the limb. See the table below for the dimensions:

Cuff Model	Arm Circumference
KM-332	17cm to 22cm
KM-341	21cm to 35cm
KM-342	27cm to 42cm
KM-343	40cm to 48cm

Note: The device is suitable for patient with more than 3 years old, and the appropriate cuff should be



selected according to the age and arm circumference of the patient.

- Too frequent measurements or connection tube kinking may result in purpura, neuralgia and lack of blood.
- Wrap the cuff and operation of the start/cancel button " are the frequently used functions.
- Do NOT apply the CUFF over a wound, as this can cause further injury.
- Operation of the device does not result in prolonged impairment of PATIENT blood circulation.
- Do NOT wrap the cuff on limbs with transfusion tubes, intubations or skin lesions on the area, as damage may be caused to the limbs.
- The equipment can be used on pregnant or pre-eclamptic patients, but should not be used on neonatal patients.
- The operating steps need to obtain accurate routine resting Blood Pressure measurement for the condition hypertension including:
  - Patient position in normal use, including comfortably seated, legs uncrossed, feet flat on the floor, back and arm supported, middle of the cuff at the level of the right atrium of the heart.
  - The patient should be as relaxed as possible and should not talk during the measurement procedure.

--5 minutes should elapse before the first reading is taken.

- Readings can be affected by the measurement site, the position of the patient(standing, sitting, lying down), exercise, or the patient's physiological condition.
- The operator should check whether the cuff is wrapped well at first if unexpected readings are obtained.
- The environment or operational factors which can affect the performance of the device and/or its blood pressure reading (e.g. common arrhythmias such as atrial or ventricular premature beats or atrial fibrillation, arterial sclerosis, poor perfusion diabetes, age, pregnancy, pre-eclampsia, renal diseases, patient motion, trembling, shivering).
- The performance of the equipment can be affected by extreme temperature, humidity and altitude.
- Avoid compressing or restricting the connection tubing.
- 🔔 Measurements should be taken at appropriate intervals. Frequent measurements with short intervals may lead to pressed arm, reduced blood flow low blood pressure, and result in an inaccurate reading. It is recommended that the measurements are taken in intervals of more than two minutes.
- 🔔 Before use, empty the cuff until there is no residual air inside. Do NOT allow the cuff to twist or

bend.

-  Do NOT twist the cuff hose or put heavy things on it.
-  Please hold the connector of the hose while connecting and disconnecting it to the device.
-  If arrhythmia or auricular fibrillation occurs, take the measurement again.

### **2.3.2 SpO<sub>2</sub> Measurement**

#### **Operation procedures:**

1. Connect the smart SpO<sub>2</sub> probe to the connector on the upper-side of the device marked "SpO<sub>2</sub>" ("PORT1" or "PORT2" for previous versions of the device). When disconnecting the connector, be sure to hold the head of the connector firmly and pull.
2. The red blinking light inside the clip of the SpO<sub>2</sub> probe indicates a successful connection.
3. Insert one finger (index finger is preferred, the nail should be not too long) into the clip of the probe according to the finger mark, shown as below.
4. The device will begin to take the measurement.

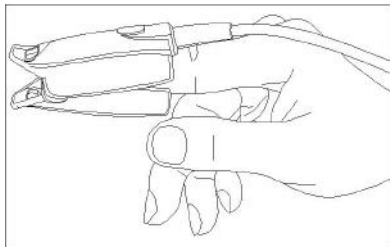

Figure 2.6 demonstration for SpO<sub>2</sub> probe

### **SpO<sub>2</sub> Measurement Principle**

SpO<sub>2</sub> measurement is based on dual wavelength opto-plethysmometry technology, a unique hardware and software design as its proprietary technology from Shenzhen Creative Industry Co., Ltd.. By use of red and infra-red light emitting through the patient's finger, the photo-detector at the other side senses the transmitted light and converts to current for later amplification and filtering. The acquired light intensity signals (plethysmogram) are digitalized and further processed with proprietary algorithm to determine the SpO<sub>2</sub> and pulse rate value.

### **Safety instructions for SpO<sub>2</sub> measurements**

- Continuous use of the SpO<sub>2</sub> probe may result in discomfort or pain, especially for those with microcirculatory problems. It is recommended that the probe should NOT be applied to the same place for over two hours, change the measurement site periodically and when necessary.



- ☛ When the ambient temperature is over 35°C, please change the measuring site every two hours; when the ambient temperature is over 37°C, please do NOT use the SpO<sub>2</sub> sensor, as using in high temperatures can cause burns.
- ☛ Do NOT place the SpO<sub>2</sub> probe on a finger with edema or fragile tissue.
- ☛ Do NOT put the SpO<sub>2</sub> probe and pressure cuff on the same limb, otherwise the blood pressure measurement may affect the SpO<sub>2</sub> measurement.
- ☛ The device is calibrated to display functional oxygen saturation.
- 🔔 Do NOT allow the sensor cable to twist or bend.
- 🔔 Check the SpO<sub>2</sub> sensor and cable before use. Do NOT use a damaged SpO<sub>2</sub> sensor.
- 🔔 When the temperature of the SpO<sub>2</sub> sensor is abnormal, do not use it further.
- 🔔 Remove nail polish or other cosmetic products from the fingernail.
- 🔔 The fingernail should be of normal length.
- 🔔 The SpO<sub>2</sub> sensor cannot be immersed into water, liquid or cleanser.
- 🔔 The SpO<sub>2</sub> sensor can be repeatedly used. Please clean and disinfect before reuse.
- 🔔 The SpO<sub>2</sub> sensor can be repeatedly used. Please clean and disinfect before reuse.
- 🔔 Anemia or low hemoglobin concentrations, intravascular dyes, carboxyhemoglobin, methemoglobin, and dysfunctional hemoglobin may effect the SpO<sub>2</sub> accuracy. If the patient has such situation, do not rely on the measured result for diagnostic decision, and it's recommended for the patient to consult

with the doctor.

 **Connectors with the label "SpO<sub>2</sub>"** can only be connected with the smart SpO<sub>2</sub> probe.

Note: The ECG and SpO<sub>2</sub> functions cannot be used simultaneously. If the device is successfully connected to both the ECG accessory and the smart SpO<sub>2</sub> probe, one function will take precedence over the other. For example, if the user presses "Start" on the ECG accessory, the SpO<sub>2</sub> probe will be temporarily disabled until the ECG measurement is terminated.

### 2.3.3 Temperature Measurement

The ear thermometer probe is a delicate transducer. To operate please follow these steps and procedures. Failure to accurately operate may cause damage to the probes.

#### 1. The ear thermometer probe

Please place the ear thermometer probe in a stable ambient temperature for 30 minutes before taking a measurement.

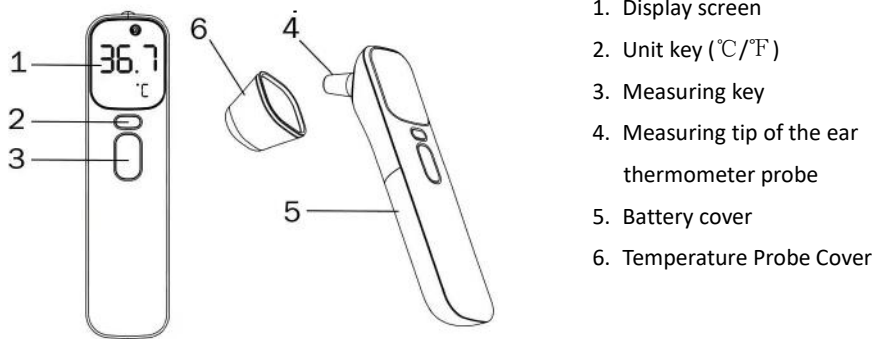



Figure 2.7 the infrared temperature probe

### **Mode of operation of the clinic thermometer: Adjusted mode**

Note: The default mode is ear temperature measurement. If you want to switch the thermometer to another mode, connect the device to the App (see 2.2.3 for details) and click the "mode" button in the temperature column of the App interface.

#### **Operation procedure:**

1. Connect the ear thermometer probe to the connector on the upper side of device marked "TEMP" ("PORT1" or "PORT2" for previous versions of the device). Press the measuring key. When the LCD screen

of the device displays "", this indicates that the probe is successfully connected.

2. When the temperature unit "°C" on the screen of the probe is blinking, the user can begin to take the measurement.

3. Take off the probe cover and insert the tip of the ear thermometer probe into the earhole, Press the measuring key to start the measurement. A short beep means the measurement has finished and the result will be displayed on the screen.

4. Press the unit key to switch between °C and °F.

#### **Note:**

➤ If the ear thermometer probe detects a hardware failure, a red screen will appear on the display screen and the probe will not enter into measuring mode. Press the measuring key to restart the

measurement.

- The ear thermometer probe will switch to stand by automatically if there is no operation for 1 minute. If a further measurement is needed, press the measuring key and repeat step 2 and step 3.
- Normal range of ear temperature: 35.8 ~ 38.0 °C
- Each person has his/her own normal temperature value, and the normal temperature value also changes at different time within a day. Therefore, it's recommended to report your doctor not only the temperature value, but also the measuring position, if possible you may provide your own normal temperature range to your doctor for reference.

### **Safety Instruction for Temperature Measurement**

- 🔊 This device meets requirements established in ASTM Standard (E1965-98).
- 🔊 Do NOT use the ear thermometer probe when the subject temperature and ambient temperature are outside the operating ranges specified by the manufacturer.
- 🔊 Performance of the device may be adversely affected when one or more of the following occur:
  - A. Operation outside of the manufacturer specified subject temperature range.
  - B. Operation outside of the manufacturer specified operating temperature and humidity ranges.
  - C. Storage outside of the manufacturer specified ambient temperature and humidity ranges.
  - D. Mechanical shock.
- 🔊 Manufacturer defined soiled or damaged infrared optical components.

- ⚠ Do NOT take a measurement when the patient is moving.
- ⚠ Patients with tympanitis and otitis problems should NOT use this device.
- ⚠ When the infrared temperature probe is connected to the device, the probe will consecutively be at power-on status, therefore pressing the power on/off key on the temperature probe will not cause any effect.

### 2.3.4 Blood Glucose Measurement (Optional)

Using the optional link cable for the **Super Check 1** Glucose Meter, connect the **Super Check 1** Glucose Meter to the connector on the right side of the Spot-Check Monitor marked "GLU" ("↑↓"). When the device shows "G--", this indicates that the blood glucose meter is linked successfully.

#### Appearance and key functions of the

#### Super Check 1 Glucose Meter:

1. Test strip slot: when the strip is inserted into the slot, the meter will automatically turn on.

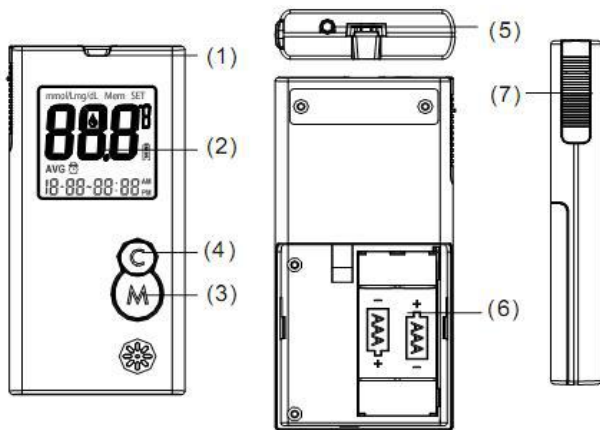

Figure 2.8 Appearance and functions of the **Super Check 1** Glucose Meter

2. LCD display.
3. M key: power on/off, also for memory recalling mode.
4. C key: Setting mode. Please refer to User Guide for "**Super Check 1 Blood Glucose Monitoring System**" for detailed function descriptions.
5. Data interface: can be used to connect the Spot-Check Monitor for data transmitting.
6. Battery compartment: insert 2 AAA size batteries with the correct polarities.
7. Ejector: remove the used strip.

#### **Operations for the Lancing Device and Blood Lancet**

1. Unscrew the lancing device by turning the end cap counter clockwise.
2. Insert a new lancet firmly into the lancet holder.
3. Twist off the protective tip of the lancet.
4. Close the end cap of the lancing device. Slide into the locking position.

Refer to figure 2.9A

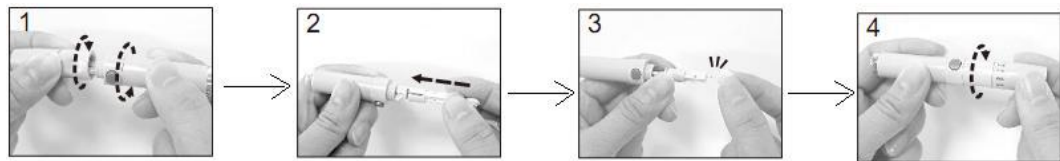

Figure 2.9A Operation for Lancing Device and Blood Lancet

**Quick operation procedure for Super Check 1 Glucose Meter:**

1. While the meter is off, insert a new test strip into the meter. The meter will automatically turn on and a blinking blood icon will be displayed on screen.

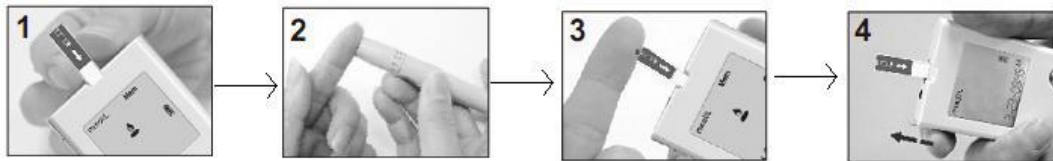



Figure 2.9B Testing instruction









2. Lance the finger and let a blood drop form.
3. When the blood drop icon is still blinking on the meter, apply the blood drop to the front edge of the test strip. The Meter will display the test result after 6 seconds
4. Remove the used strips by hand or by pushing the ejector and the meter will turn off and display "OFF" on the screen.

**Refer to the provided user guide for the "Super Check 1 Blood Glucose Monitoring System" for further detailed instructions.**

**Safety Instructions for Blood Glucose Measurement**

-  The provided test strips should be used with the Super Check 1 Glucose Meter.
-  Do NOT clean or disinfect the finger with iodine.



-  The calibration code must be the same with that on the packaging.
-  The Super Check 1 Glucose Meter will automatically switch to stand-by mode if a test strip is not inserted for 1 minute.
-  The test strip will draw blood at one end automatically.
-  Do NOT press or scrape the bleeding finger.
-  The test strip should be used as soon as possible after unpacking, and the unused strips should be kept in an airtight bottle.
-  Only take one measurement per minute
-  If the monitor is connected with both the temperature probe and the blood glucose meter, the screen will show "".
-  The blood collection pinhead is a disposable item. It is recommended to insert it back into the plastic cover and throw it into a specific dustbin.

### **2.3.5 ECG Measurement (Optional)**

1. Connect the ECG accessory to the connector on the upper side of device marked "ECG" ("PORT1" or "PORT2" for previous versions of the device).
2. Choose one of the methods (refer to figure 2.10B/C/D/E) to take the ECG measurement.
3. When the ECG accessory is connected to Spot-Check Monitor successfully, press the "Start" button on the ECG accessory to activate the ECG measurement.

4. When "ECG" appears on the display screen of the Spot-Check Monitor, it means the ECG accessory has begun to take the ECG measurement.
5. 30 Seconds later, the result will display on the screen of the terminal device, and the measurement will terminate.

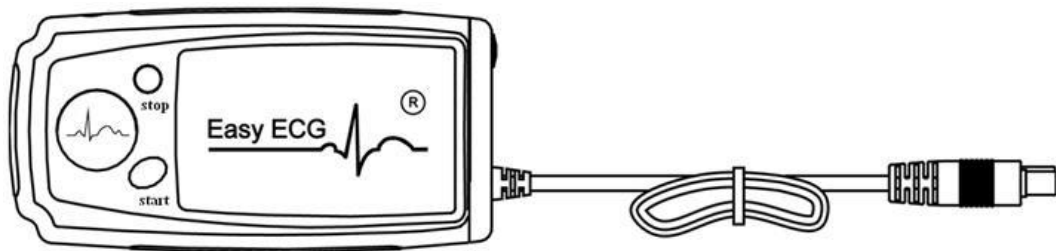

Figure 2.10A ECG accessory

- Start / Stop: Start/Stop ECG measurement.



Figure 2.10B  
Palm measurement

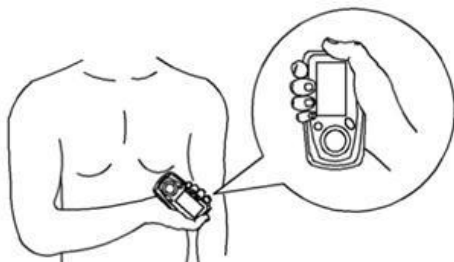

Figure 2.10C  
Chest measurement



Figure 2.10D  
Leg measurement

To obtain a clear and high quality ECG signal, the lead wire measurement can be used. Connect the lead wire firmly to the lead wire socket of the device. Place the electrodes and connect the lead wires as shown in Figure 2.10E to obtain the Lead II ECG signal. If you want to measure Lead I and Lead III ECG signal, connect the lead wires to the electrodes (note: lead wire is optional) as detailed in table below.

➤ **Safety Instructions for ECG Measurement**

1. Check the device to make sure that there is no visible damage that may affect the user's safety and the measurement performance.  
If there is obvious damage, stop using the unit.
2. Do NOT make a diagnosis of oneself according to the measurement results, always consult a doctor if abnormal information is presented frequently.

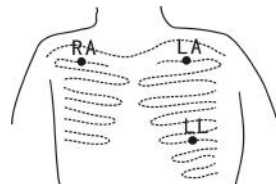

Figure 2.10E Lead wire measurement

3. Do NOT use the device in a bathroom or humid environments.

**Table 1 ECG Leads Configuration and Electrodes Location**

<b>Electrode Name&amp; Color</b> <b>Electrode Location</b>	<b>Lead</b> <b>Lead I</b>	<b>Lead II</b>	<b>Lead III</b>
The intersection between the centerline of the right clavicle and Rib 2.	R (Red)/ RA(White)	R (Red)/ RA(White)	L (Yellow)/ LA(Black)
The intersection between the centerline of the left clavicle and Rib 2.	F (Green)/ LL(Red)	L (Yellow)/ LA(Black)	R (Red)/ RA(White)
Between the left edge of the breast bone and Rib 5	L(Yellow)/ LA(Black)	F (Green)/ LL(Red)	F (Green)/ LL(Red)

## 2.4 Blood Pressure Accuracy Check Method

### Operation procedure:

1. Unscrew the M3x6 screw from the battery compartment on the back of the Spot-Check Monitor, as shown in figure 2.11.
2. Take a NIBP connector plug from the battery cover, as shown in figure 2.12. (Note: there are two plugs but you will only need one.)
3. Air Path Connection: Take a piece of air tube (0.5~1m long,  $\Phi 8.0\text{mm}/\Phi 4.0\text{mm}$  diameter). Attach the NIBP connector with a connector plug on to one end of the air tube. Connect the other end to the 3-way connector. Connect the other 2 ends of the 3-way connector to a Mercury Sphygmomanometer as shown in Figure 2.13.
4. Connect the NIBP connector end to the NIBP port on the Spot-Check Monitor as shown in figure 2.14.
5. Turn on the Spot-Check Monitor. Press the menu button to go to the settings. Press and hold the large NIBP measurement button to enter the Pressure Check Mode.
6. Start pumping, and check if the pressure reading on the Spot-Check Monitor matches the mercury pressure reading.

M3x6 Screw

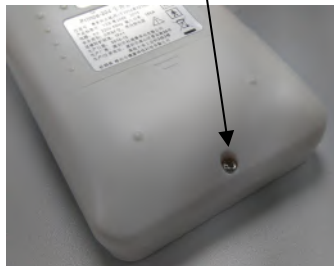

Figure 2.11

NIBP Connector Plug



Figure 2.12

Air tube

NIBP Connector

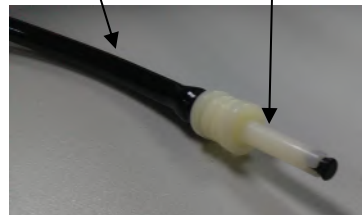

Figure 2.13

NIBP Port

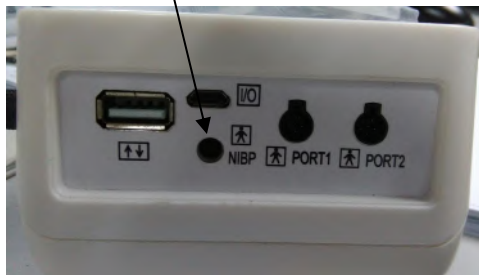













Figure 2.14











Figure 2.15

## 2.5 Symbols

Symbol	Description	Symbol	Description
	Wireless		Pulse rate (unit: bpm, beat per min)
	Beep sound indicator		Battery voltage indicator
	Memory icon		USB icon
	Pulse strength bar graph	bpm	Unit of pulse rate
°C/°F	Unit of temperature	kPa/mmHg	Unit of blood pressure
	Power on/off switch	DC 5.0V 1.2A 	External DC power input
	Type BF applied parts		Charger or USB data interface

## User Manual for Spot-Check Monitor

SN	Serial Number		Connector to link with blood glucose meter
	Refer to manual		Follow WEE regulations for disposal
TEMP	Connector for temperature probe	SpO <sub>2</sub>	Connector to smart SpO <sub>2</sub> probe
NIBP	Connector for cuff		Battery cover
ECG	Connector for ECG accessory		No Alarms
	Manufacturer information		Date of manufacture
	Authorised representative in the European community		UK Responsible Person



## CHAPTER 3 MONITORING SCREEN DISPLAY







### 3.1 Measuring Screen



Figure 3.1B Measuring screen

#### Screen Description:

1. : USB connection icon
2. : wireless transmission icon; "": means that the wireless transmission function is on; when the icon is blinking, the wireless connection set up is unsuccessful; when this icon is steady, the wireless connection set up is successful; "": the wireless transmission function is off.

3. : Beep sound indicator; : pulse beep is on; : pulse beep is off.
4. : Battery voltage indicator. When the battery is full, the battery voltage indicator displays a full grid. When the indicator is blinking, it means the battery voltage is low and the user should charge the battery. Please connect the device to the external power supply to ensure the correct use of the monitor, and the battery will be charged. During charging, the grids in the battery indicator will roll circularly.
- 5~10. : Means the inflation pressure during cuff inflation. When displaying the measurement result, the description for the pressure will be displayed, such as O (Optimal), N (Normal), H (High normal), G1 (Grade 1 hypertension), G2 (Grade 2 hypertension), and G3 (Grade 3 hypertension).
11. M: Memory
12. ID: the patient ID, which can be set from 0 to 99.
13. NO.: the number of stored data, up to 999 records can be stored for each ID.
14. H:M: the time stamp (hour:minute). The time can be set in the system setup screen.
15. M-D: the time stamp (month-day). The date can be set in the system setup screen.
16. SYS: Systolic pressure
17. DIAS: Diastolic pressure
18. kPa/mmHg: unit of blood pressure, 1kPa=7.5mmHg.
19. SpO<sub>2</sub>: the value of SpO<sub>2</sub> with unit of %.
20. : Pulse bar-graph.
21. PR: Pulse rate with unit of bpm.
22. : the heart beat symbol, which flashes with heart beat.

23. TEMP/BG: the current displayed temperature with an option of °C for Celsius, or °F for Fahrenheit.

When the optional BG is chosen, the blood glucose value will be displayed with the default unit of mmol/L.

### 3.2 System Setting Screen







On the measurement display screen, press and hold the menu key to setup the display screen, as shown in figure

3.2. The user can choose the settings for the wireless function, pulse beep, blood pressure unit, temperature unit, date and time



Figure 3.2 Setup display screen

**Operation Instructions:**

1. Press and hold the "" key, and release after hearing one beep, to enter into the setup screen. When the patient ID blinks, the setup function is available.
2. A short press of the "" key enables or disables the wireless transmission function.
3. A short press of the "" key confirms the setting. The beeping mark "" will blink.
4. A short press of the "" key enables or disables the pulse beep.
5. A short press of the "" key confirms the setting. The "kPa" (blood pressure unit) will blink.  
The functions of wireless transmission, beep, blood pressure unit, temperature unit, date and time can be set by following the above steps.
6. Press and hold the "" key to bring the screen display back to the measurement display screen. The monitor will also switch back to the measurement display screen if there has been no operation for 30 seconds.

Note:1. On the setup display screen, all parameters can be set in anticlockwise order by pressing and holding the "" key.



- For setting the date, the century is fixed to be 20, i.e. "13y" indicates the year 2013. Please see the following example for the date and time: 11:14", March 23, 2013.

### 3.3 History Data Review Screen

On the measurement display screen, press and hold the



" key to recall the stored data records, as shown in

figure 3.3

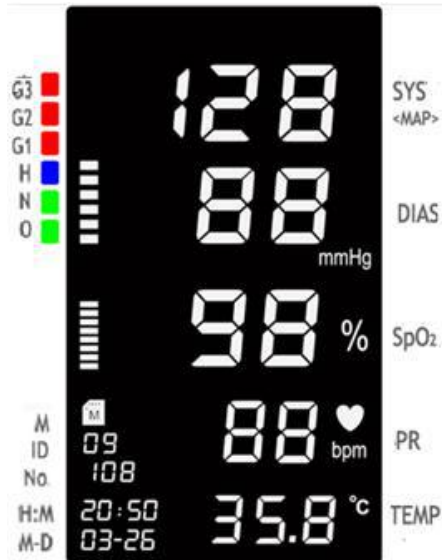









Figure 3.3 History data review screen

### Operation instructions:

1. Press and hold the " " key, release the key after hearing one beep. The memory mark " " will appear (i.e. entering to review display screen). The patient's ID number will blink at the same time.
2. A short press of the " /  " key will browse the patient's ID numbers.
3. A short press of the " " key will confirm the setting, and the recorded number (No.) will blink.
4. A short press of the " /  " key will set the recorded number to be recalled. The data displayed on the screen is for the specific record of the patient selected.

Note: when selecting the patient ID, the screen only displays patients with history data records.

### 3.4 Data Uploading

1. When the wireless transmission function is on, the monitor can communicate with a host device such as a PC, smart phone or other wireless enabled devices for real-time data transmissions.
  - A. Open the host's wireless function and procedure and start to scan the Spot-Check Monitor.

- B. The host will pair with the Monitor at a moment.
- C. After connecting, the host can display and manage the measurement data of the Monitor by wireless.
- The pairing and transmitting distance of wireless function is 8 meters in the normal. If the host can't pair with the Monitor, you can try to narrow the distance between the host and the Monitor.
  - The Monitor can pair and transmit with the host under the wireless coexistence environment, but other wireless device may still interface with pairing and transmission between the host and the Monitor under uncertain environment. If the host and the Monitor display inconsistent, you may need to change the environment.
2. When connected to a USB cable, the history data (including the measured SpO<sub>2</sub>, PR, TRMP and ECG data etc.) can be uploaded to a PC for viewing and management.

## CHAPTER 4 TECHNICAL SPECIFICATIONS

### 4.1 Blood Pressure Measurement

1. Technique: Oscillometric
2. Pressure measuring range (Adult/Pediatric): 0mmHg~300mmHg
3. Accuracy of pressure measurement:  $\pm 3$ mmHg
4. Cuff inflation time:<20 seconds (typical adult cuff)
5. Overpressure protection limit (Adult/Pediatric):  $\leq 300$ mmHg(39.9kPa)
6. Blood pressure measurement range (Adult/Pediatric):  
SYS: 60mmHg~240mmHg      DIA: 30mmHg~180mmHg
7. Blood pressure measurement accuracy:

Maximal mean difference:  $\leq \pm 5$ mmHg (0.67kPa)

Maximal standard deviation:  $\leq 8$ mmHg (1.067kPa)

Note: The device is suitable for patient with more than 3 years old, and the appropriate cuff should be selected according to the age and arm circumference of the patient.



## 4.2 SpO<sub>2</sub> Measurement

1. Technique: optical with dual-wavelength

LED wavelength: Red light: 663nm, Infrared light: 890nm

Maximal optical output power: less than 2mW maximum average

2. SpO<sub>2</sub> display range: 0%~100%

3. SpO<sub>2</sub> measuring accuracy: Arms is not greater than 3% for SpO<sub>2</sub> range from 70% to 100%, undefined during range 0%~70%.

Note:  $A_{rms}$  is defined as root-mean-square value of deviation according to ISO 80601-2-61 / ISO 9919

4. Measuring mode: spot-checking

5. SpO<sub>2</sub> display update: every second

6. Low perfusion performance: the above declaration is still attained while the amplitude modulation ratio is as low as 0.6%.

7. The table with measured SpO<sub>2</sub> accuracy specification in the discrete SpO<sub>2</sub> ranges:

SaO <sub>2</sub> range	Arms
70%~80%	1.62
80%~90%	1.09

## User Manual for Spot-Check Monitor

90%~100%	1.58
70%~100%	1.42

### 8. The graphical plot of all sampled data points:

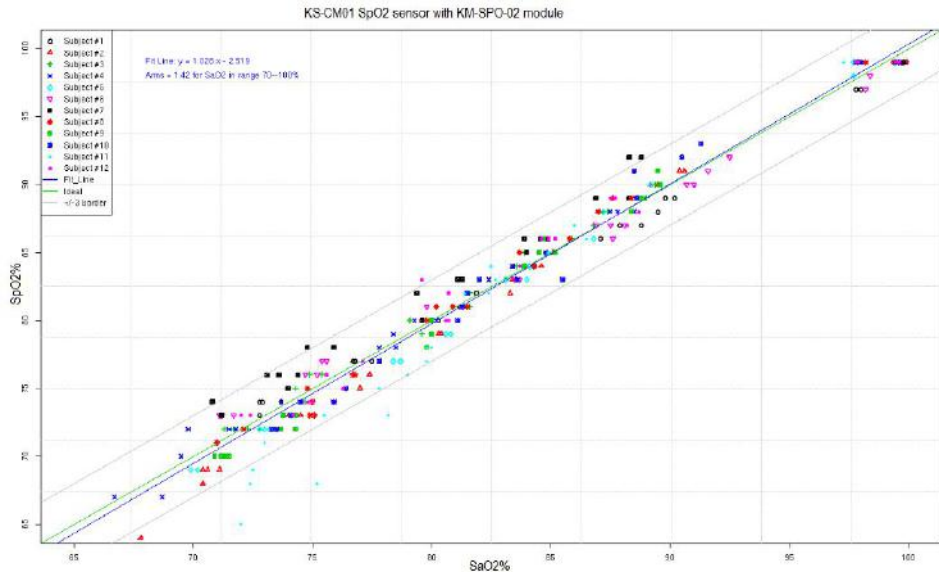

Note: The PC-303 data is obtained from UP-700C (K123711), which has the same technology as the

PC-303, through a controlled, induced hypoxia study, which was conducted with healthy adult volunteers. The PC-303 uses the same SpO<sub>2</sub> measurement technology provided in the subject device.

### **4.3 Pulse Rate Measurement**

1. PR measuring range: 30bpm~240bpm
2. Pulse rate measuring accuracy:  $\pm 2$ bpm or  $\pm 2\%$ , which is greater

### **4.4 Temperature Measurement**

1. Measuring range: 32.0°C~43.0°C
2. Measuring accuracy:  $\pm 0.2^{\circ}\text{C}$  is for TEMP range from 36.0°C to 39.0°C, and  $\pm 0.3^{\circ}\text{C}$  is for the rest;  $\pm 0.4^{\circ}\text{F}$  is for TEMP range from 96.8°F to 102.2°F, and  $\pm 0.5^{\circ}\text{F}$  is for the rest.
3. Response time:  $\leq 5$ s
4. When the temperature is lower than the measurement range, the thermometer and the device display L---°C. When the temperature is higher than the measurement range, the thermometer and the device display H---°C.

### **4.5 Blood Glucose Measurement (Optional)**

1. Technique: Amperometric, glucose oxidase

2. Measuring range: 1.1mmol/L~33.3mmol/L (20~600mg/dL)
3. Measuring time: 6 seconds

#### **4.6 ECG Measurement (Optional)**

1. Heart Rate measuring range: 30bpm~240bpm
2. Heart Rate measuring accuracy:  $\pm 2$ bpm or  $\pm 2\%$  whichever is greater
3. Display scale: 5.0mm/mV $\pm 10\%$
4. Common-mode rejection ratio (CMRR):  $\geq 60$ dB

#### **4.7 Others**

##### **4.7.1 Operating Environment**

1. Operating temperature: 5 $^{\circ}$ C ~ 40 $^{\circ}$ C;                      Relative humidity: 30% ~ 80%;  
Atmospheric pressure: 70.0kPa ~ 106.0kPa;                      Power supply: 110V-240VAC, 50/60Hz, 15VA;  
Internal power supply: 3.7VDC(rechargeable Lithium battery);
2. The device should be situated in a place protected against direct sunlight, to prevent overheating inside of the equipment.
3. Do not use this equipment in combination with any equipment other than those approved in the user

manual.

4. The device should be stored and used in a specified temperature, humidity and atmospheric pressure range, or damage may be caused to the device and as a consequence, record inaccurate results.
5. If the device gets wet by accident, the operator should NOT turn on the power until it has been thoroughly air dried.
6. Do not use this equipment in an environment with toxic or inflammable gases.
7. Only monitor a single person at a time.
8. Do not expose the device to a magnetic resonance (MR) environment.
  - ✧ The device may present a risk of projectile injury due to the presence of ferromagnetic materials that can be attracted by the MR magnet core.
  - ✧ Thermal injury and burns may occur due to the metal components of the device that can heat during MR scanning.
  - ✧ The device may generate artifacts in the MR image.
  - ✧ The device may not function properly due to the strong magnetic and radiofrequency fields generated by the MR scanner.

**Warning:** Do not use any other adapters than those provided by Creative.

#### **4.7.2 Classification**

1. Protection against electric shock: Class II equipment and internally powered equipment
2. The degree of protection against electric shock: Type BF applied part
3. Define apply part: cuff, SpO<sub>2</sub> probe, temperature probe, ECG lead wires (optional).
4. The degree of protection against harmful ingress of liquid: The equipment is IP22 with protection against ingress of liquid
5. Electro-magnetic Compatibility: Group I, Class A

## CHAPTER 5 TROUBLESHOOTING

Trouble	Possible reason	Solution
Cannot turn on the device	The built-in battery is drained	Recharge by connecting the power supply adapter
	Battery is not installed	Install the Lithium battery
	Some parts provided by other manufacturers are inserted to the connector	Remove the related parts and try again.
No blood pressure result	The cuff is wrapped around the arm incorrectly	Wrap the cuff around the arm correctly
	The windpipe is not correctly inserted to the NIBP jack	Insert the windpipe to the NIBP jack
No SpO <sub>2</sub> result	The SpO <sub>2</sub> probe is not plugged into the "SpO <sub>2</sub> " connector (or Port1 or Port2)	Plug the SpO <sub>2</sub> probe into the "SpO <sub>2</sub> " connector (or Port1 or Port2)
No TEMP result	The temperature probe is not correctly plugged into "TEMP" connector (or Port1 or Port2)	Plug the temperature probe into "TEMP" connector (or Port1 or Port2)

## CHAPTER 6 ERROR MESSAGE INTERPRETING

<b>Error Code</b>	<b>Description</b>
ERR 00	No valid pulse is detected
ERR 01	Fail to inflate pressure to 30 mmHg within 7 seconds (The cuff is not well-wrapped)
ERR 02	Invalid measured result
ERR 03	Cuff pressure is over 295 mmHg (Overpressure protection)
ERR 04	Excessive motion artifact



**CHAPTER 7 PACKING LIST**

<b>Item</b>	<b>Description</b>	<b>Model</b>	<b>Quantity</b>	<b>Check</b>
1	Spot-Check Monitor	PC-303	One piece	Standard
2	Handbag	/	One piece	Standard
3	User Manual	/	One piece	Standard
4	Cuff	KM-341	One piece	Standard
5	USB cable	/	One piece	Standard
6	Charger (with USB socket)	LXCP12-005	One piece	Optional
7	Ear thermometer probe	KT-602	One piece	
8	Smart SpO <sub>2</sub> probe	KRK3	One piece	
9	<b>Super Check 1</b> Glucose Meter (with lancing device and link cable )	G-777G	One set	
10	Blood glucose test strips (with blood lances)	/	One pack	
11	Spot-Check Monitor Data Manager Software	/	One set	
12	ECG accessory	H600	One piece	

---

User Manual for Spot-Check Monitor

---

13	ECG lead wire (snap)	/	One piece	
14	Disposable adhesive ECG electrodes	/	Six pieces	

## **CHAPTER 8 MAINTENANCE AND SERVICE**

The Spot-Check Monitor should be properly maintained to ensure its maximum performance and long service life. In addition to the warranty period, the company also offers long-term service for each customer. It is important that the user reads and follows the operation instructions, important information and maintenance measures.

### **8.1 Technical Maintenance**

#### **8.1.1 Daily Examination**

Before using the monitor, the following checks should be carried out:

- Check the monitor for any mechanical damage;
- Inspect the exposed parts and the inserted parts of all the leads, and the accessories;
- Examine all the functions of the monitor that are likely to be used for patient monitoring, and ensure that it is in good working condition.

If there is any indication of damage, or if damage is accurately proven, do not use the device. Contact your supplier for advice and to reach a satisfaction solution.

#### **8.1.2 Routine Maintenance**







The PC-303 Spot-Check monitor is designed to have a life expectancy of at least 5 years. In order to ensure precise readings, it is recommended to test the pressure accuracy every year. Please see section

2.4 to perform the Blood Pressure Accuracy Check Method or contact your supplier for more information. After each maintenance or yearly maintenance, the monitor should be thoroughly inspected by a qualified personnel, including an inventory of all functions and safety examinations.



- If the hospital fails to carry out a satisfactory maintenance program on the monitor, it may cause harm to the patient.
- If there is any indication of cable and transducer deterioration or damage, please do not use.
- The SpO<sub>2</sub> function has been adjusted before vending. If the user needs to adjust the SpO<sub>2</sub>, adjust by using the simulator mode FLUKE INDEX2.
- 🔔 Any adjustable unit or component inside the monitor cannot be adjusted without permission so as to avoid unnecessary failures that may affect the normal application.
- 🔔 It is recommended to use the battery once a month to ensure a strong power supply capacity and long service life, and recharge once the power has completely run out.

### 8.1.3 Battery Maintenance











- Please pay attention to the polarity of the battery, do NOT insert into the battery compartment with reversed polarities.
- In order to avoid damaging the battery, do NOT use other power supply devices to charge the battery.
- After use, dispose of the battery according to local regulations, do NOT throw into fire.

-  Do NOT hit or strike the battery with force.
-  Do NOT use this battery in other devices.
-  Do NOT use this battery below  $-20^{\circ}\text{C}$  or above  $60^{\circ}\text{C}$ .
-  In order to maintain the battery supply and prolong the battery lifetime, please charge the battery routinely. Regularly, charge the battery every 3 months even if the device has not been used.
-  Only use a battery with the specification recommended by the manufacturer.
-  Whether the monitor is on or off, the built-in battery will charge as long as the monitor is connected to an AC adapter and the AC power is on. When the battery is full, it will stop charging to avoid causing any damage. If the monitor is connected to an AC adapter and the AC power is on, it will use the AC power, but when the AC power is off, the battery power will be used. Priority of using the AC power and the power switch between AC and battery is automatic and seamless.
-  If the battery is damaged, please replace it with a battery with "CCC" or "CE" mark. The model and specifications of the battery should be the same as the original battery. The user must ensure that the battery meets all applicable safety codes. The user can also contact the distributor for service.

## 8.2 Cleaning and Disinfection of the Main Unit









-  Switch off the monitor and disconnect the power cord before cleaning.
-  Keep the monitor free from dust.
-  It is recommended to regularly clean the outer shell and screen of the monitor. Only use a

non-corrosive cleanser such as clear water.

-  Wipe the surface of the monitor and transducers with an alcohol impregnated wipe, and dry with a clean cloth or just air-dry.
-  Dilute the cleaner.
-  Do NOT use scrubbing materials.
-  The monitor can be disinfected. To avoid damage do not let liquid cleaner flow into the connector jack of the monitor.
-  Clean the exterior of the connector only.
-  Do NOT let any liquid flow into the shell or any other parts of the monitor.
-  Do NOT leave any residue liquid or disinfectant on the surface of the monitor.
-  Do NOT perform high pressure sterilization on the monitor.
-  Do NOT immerse any parts of the monitor or its accessories in liquid.
-  If the monitor accidentally becomes wet, it should be thoroughly dried before use. The rear cover can be removed by a qualified service technician to verify the absence of water.
-  Do NOT pour disinfectant on the monitor's surface while disinfecting.

### **8.3 Cleaning and Disinfection of Accessories**

It is recommended to clean and disinfect the accessories (excluding the SpO<sub>2</sub> probe) with a piece of gauze soaked in 75% Alcohol or 70% Isopropanol.

-  Do not use damaged accessories.
-  Accessories cannot be entirely immersed into water, liquid or cleanser.
-  Do NOT use radiation, steam or epoxyethane to disinfect accessories.
-  To prevent cross infection, the user wipes the temperature sensitive probe with 75% alcohol before and after use, then wipes the residue clean with clean dry cloth.
-  Wipe off any remaining residue of alcohol or isopropanol after disinfection.
-  Disinfect the temperature sensitive probe with alcohol.
-  Wipe the thermometer clean with a mild cloth if it becomes dirty.
-  Wipe the thermometer clean and return to packaging after use.

## 8.4 Storage

If the equipment will not be used for a long time period of time, wipe it clean and return it to the packaging. Store in a dry well ventilated place free from dust and corrosive gases.

Storage environment: Ambient temperature: -20°C~60°C

Relative humidity: 10%~95%, non-condensing

Atmospheric pressure: 53.0kPa~106.0kPa

## **8.5 Transportation**

The monitor should be transported by land (vehicle or railway) or air in accordance with the contractual terms. Do NOT hit or drop with force.



**Appendix I Classification of Blood Pressure Level**

<b>Category</b>	<b>SYS (mmHg)</b>	<b>DIA (mmHg)</b>
Optimal	<120	<80
Normal	<130	<85
High normal	130~139	85~89
Grade 1 hypertension (Mild hypertension)	140~159	90~99
Grade 2 hypertension (Moderate hypertension )	160~179	100~109
Grade 3 hypertension (Severe hypertension )	≥180	≥110
Isolated systolic hypertension	≥140	<90

**Reference: The 1999 WHO-ISH Guidelines for the Management of Hypertension**

## Appendix II EMC Compliance

Note:

Warnings:

- The instrument conforms to the requirements of IEC60601- 1 - 2 , EN 60601-1-2 standards for electromagnetic compatibility.
- The user shall install and use the EMC information provided in the random file.
- Portable and mobile RF communication equipment may affect the performance of the instrument, avoid strong electromagnetic interference when using, such as close to the mobile phone, microwave oven, etc .
- The guidance and manufacturer's declaration are detailed in the table below .
- The instrument should not be close to or stacked with other equipment. If it must to be close to or stacked, it should be observed and verified to be able to operate normally under its configuration.
- In addition to the cables sold by the instrument manufacturer as spare parts for internal components, the use of other accessories and cables may result in increased emission or reduced immunity.

Table 1

Guidance and manufacturer's declaration-electromagnetic emission		
The Spot-Check Monitor is intended for use in the electromagnetic environment specified below. The customer or the user of the Spot-Check Monitor should assure that it is used in such an environment.		
Emissions test	Compliance	Electromagnetic environment-guidance
Conducted emissions CISPR 11	Group 1 Class A	The Spot-Check Monitor uses RF energy only for its internal function. Therefore, its RF emissions are very low and are not likely to cause any interference in nearby electronic equipment.
Radiated emissions CISPR 11		
Harmonic emissions IEC61000-3-2	Class A	The Spot-Check Monitor suitable for use in all establishments,

User Manual for Spot-Check Monitor

Voltage fluctuations/flicker emissions IEC61000-3-3	Complies	including domestic establishments and those directly network that supplies buildings used for domestic purposes.
--	----------	--

Table 2

Guidance and manufacturer's declaration-electromagnetic emission			
The Spot-Check Monitor is intended for use in the electromagnetic environment specified below. The customer or the user of the Spot-Check Monitor should assure that it is used in such an environment.			
Immunity test	IEC60601 test level	Compliance level	Electromagnetic environment -guidance
Electrostatic discharge(ESD) IEC61000-4-2	±8 kV contact ±2 kV, ±4 kV, ±8 kV, ± 15 kV air	±8 kV contact ±2 kV, ±4 kV, ±8 kV, ± 15 kV air	Floors should be wood, concrete or ceramic tile. If floors are covered with synthetic material, the relative humidity should be at least 30%

User Manual for Spot-Check Monitor

<p>Electrical fast transient/ burst IEC61000-4-4</p>	<p><math>\pm 2\text{kV}</math> for power Supply lines <math>\pm 1\text{kV}</math> for Input a.c. Power Ports</p>	<p><math>\pm 2\text{kV}</math> for power Supply lines <math>\pm 1\text{kV}</math> for Input a.c. Power Ports</p>	<p>Mains power quality should be that of a typical commercial or hospital environment.</p>
<p>Surge IEC 61000-4-5</p>	<p><math>\pm 0.5\text{ kV}</math>, <math>1\text{kV}</math> line (s) to line(s) <math>\pm 0.5\text{ kV}</math>, <math>\pm 1\text{ kV}</math>, <math>\pm 2\text{kV}</math> line(s) to earth</p>	<p><math>\pm 0.5\text{ kV}</math>, <math>1\text{kV}</math> line (s) to line(s) <math>\pm 0.5\text{ kV}</math>, <math>\pm 1\text{ kV}</math>, <math>\pm 2\text{kV}</math> line(s) to earth</p>	<p>Mains power quality should be that of a typical commercial or hospital environment.</p>

User Manual for Spot-Check Monitor

<p>Voltage dips, short interruptions and voltage variations on power supply input lines IEC61000-4-11</p>	<p>&lt;5% UT (&gt;95% dip in UT) for 0.5 cycle &lt;40% UT (60% dip in UT) for 5 cycles &lt;70% UT (30% dip in UT) for 25 cycles &lt;5% UT (&gt;95% dip in UT) for 5 s</p>	<p>&lt;5% UT (&gt;95% dip in UT) for 0.5 cycle &lt;40% UT (60% dip in UT) for 5 cycles &lt;70% UT (30% dip in UT) for 25 cycles &lt;5% UT (&gt;95% dip in UT) for 5 s</p>	<p>Mains power quality should be that of a typical commercial or hospital Environment .If the user of BSV-2200 infusion pump requires continued operation during power mains interruptions, it is recommended that BSV-2200 infusion pump should be powered from an uninterruptible power supply or a battery</p>
---	---	---	---

User Manual for Spot-Check Monitor

Power frequency(50Hz/60Hz) magnetic field IEC61000-4-8	30A/m	30A/m	Power frequency magnetic fields should be at levels characteristic of a typical location in a typical commercial or hospital environment.
---	-------	-------	---

NOTE: UT is the a.c. mains voltage prior to application of the test level.

Table 3

Guidance and manufacturer's declaration – electromagnetic immunity			
The Spot-Check Monitor is intended for use in the electromagnetic environment specified below. The customer or the user of The Spot-Check Monitor should assure that it is used in such an electromagnetic environment.			
Immunity test	IEC60601 test level	Compliance level	Electromagnetic environment -guidance

User Manual for Spot-Check Monitor

<p>Conducted RF IEC61000-4-6</p>	<p>0,15MHz–80MHz 3 V RMS outside the ISM band, 6 V RMS in the ISM</p>	<p>0,15MHz–80MHz 3 V RMS outside the ISM band, 6 V RMS in the ISM</p>	<p>Portable and mobile RF communications equipment should be used no closer to any part of The Spot-Check Monitor, including cables, than the recommended separation distance calculated from the equation applicable to the frequency of the transmitter. Recommended separation distance <math>d=1.2\sqrt{P}</math></p>
<p>Radiated RF IEC61000-4-3</p>	<p>80 MHz to 2.7 GHz</p>	<p>80 MHz to 2.7 GHz 3V/m</p>	<p><math>d=1.2\sqrt{P}</math> 80MHz to 800MHz <math>d=2.3\sqrt{P}</math> 800MHz to 2.5GHz Where P is the maximum output power rating of the</p>



	3V/m	<p>transmitter in watts (W) according to the transmitter manufacturer and d is the recommended separation distance in metres (m). b Field strengths from fixed RF transmitters, as determined by an electromagnetic site survey ,a should be less than the compliance level in each frequency range .b Interference may occur in the vicinity of equipment marked with the following symbol. </p>
--	------	--

NOTE 1: At 80 MHz and 800 MHz, the higher frequency range applies.

NOTE 2: These guidelines may not apply in all situations. Electromagnetic propagation is affected by absorption and reflection from structures, objects and people.

a: Field strengths from fixed transmitters, such as base stations for radio (cellular / cordless) telephones and land mobile radios, amateur radio, AM and FM radio broadcast and TV broadcast cannot be predicted theoretically with accuracy. To assess the electromagnetic environment due to fixed RF transmitters, an electromagnetic site survey should be considered. If the measured field strength in the location in which The Spot-Check Monitor is used exceeds the applicable RF compliance level above, The Spot-Check Monitor should be observed to verify normal operation. If abnormal performance is observed, additional measures may be necessary, such as re-orienting or relocating The Spot-Check Monitor.

b: Over the frequency range 150 kHz to 80 MHz, field strengths should be less than 3V/m.

Table 4

Frequency Range and Level: RF wireless communication equipment

Test Frequency (MHz)	Modulation	Minimum immunity Level (V/m)	immunity Level Applied (V/m)
----------------------	------------	------------------------------	------------------------------

User Manual for Spot-Check Monitor

385	<b>**Pulse Modulation: 18 Hz</b>	27	27
450	<input checked="" type="checkbox"/> *FM + 5 Hz deviation: 1 kHz sine  <input type="checkbox"/> **Pulse Modulation: 18 Hz	28	28
710 745 780	<b>**Pulse Modulation: 217 Hz</b>	9	9
810 870 930	<b>**Pulse Modulation: 18 Hz</b>	28	28
1720 1845 1970	<b>**Pulse Modulation: 217 Hz</b>	28	28
2450	<b>**Pulse Modulation: 217 Hz</b>	28	28

User Manual for Spot-Check Monitor

5240	**Pulse Modulation: 217 Hz	9	9
5500			
5785			

ATTENTION:

If necessary to achieve the IMMUNITY TEST LEVEL, the distance between the transmitting antenna and the ME EQUIPMENT or ME SYSTEM may be reduced to 1 m. The 1 m test distance is permitted by IEC 61000-4-3.

- a) For some services, only the uplink frequencies are included
- b) The carrier shall be modulated using a 50 % duty cycle square wave signal.
- c) As an alternative to FM modulation, 50 % pulse modulation at 18 Hz may be used because while it does not represent actual modulation, it would be worst case.

Table 5

Recommended separation distances between portable and mobile RF communication the equipment

The Spot-Check Monitor is intended for use in an electromagnetic environment in which radiated RF disturbances are controlled. The customer or the user of The Spot-Check Monitor can help prevent electromagnetic interference by maintaining a minimum distance between portable and mobile RF communications equipment (transmitters) and the Spot-Check Monitor as recommended below, according to the maximum output power of the communications equipment.

Rated maximum output power of transmitter W(Watts)	Separation distance according to frequency of transmitter M(Meters)		
	150kHz to 80MHz	80MHz to 800MHz	80MHz to 2,5GHz
	$d=1.2 \sqrt{P}$	$d=1.2 \sqrt{P}$	$d=2.3 \sqrt{P}$
0,01	N/A	0.12	0.23
0,1	N/A	0.38	0.73
1	N/A	1.2	2.3
10	N/A	3.8	7.3
100	N/A	12	23

For transmitters rated at a maximum output power not listed above, the recommended separation distance in metres (m) can be determined using the equation applicable to the frequency of the transmitter, where  $P$  is the maximum output power rating of the transmitter in watts (W) according to the transmitter manufacturer.

NOTE 1 : At 80 MHz and 800 MHz, the separation distance for the higher frequency range applies.

NOTE 2 : These guidelines may not apply in all situations. Electromagnetic propagation is affected by absorption and reflection from structures, objects and people.

## Quality Certificate

Name: Spot-Check Monitor

Model: \_\_\_\_\_

Date: \_\_\_\_\_

QA: \_\_\_\_\_

This product has been inspected in accordance with the standards specified in the User Manual.

Shenzhen Creative Industry Co., Ltd

## Warranty Clause

1. This monitor has a warranty of 12 months (including rechargeable battery) and 6-month for all accessories, from the date of purchase.
2. It is recommended to use the original packing boxes and packing materials when returning for repair or maintenance
3. Please send the device to the specified place for repair.
4. The following will invalidate the warranty:
  - ◇If the monitor is damaged due to misuse or incorrect operation (i.e. without the user manual instruction.
  - ◇The monitor is damaged due to incorrect connection with another instrument
  - ◇The monitor is accidently damaged, dropped or immersed into water
  - ◇If the user modifies or changes the monitor without written authority of the company
  - ◇If the serial number is deliberately damaged, torn off or unreadable
5. If the monitor is non-functional outside of the warranty period, the manufacturer or distributor will offer an estimate for repair.



## Warranty

Device Information:			
Name		Model	
Serial Number:			
Date		Shop	
User Information:			
Name		Postcode	
Tel:			
Add:			
Repair Record			
Date	Repairing Item	Personnel	

## Patent

State Intellectual Property Office of the P.R.C. patented and certificated Creative Spot-Check Monitor on March 26<sup>th</sup>, 2014.

Patent Number: ZL 2013 2 0615696.X



**Shenzhen Creative Industry Co., Ltd.**

**Floor 5, BLD 9, Baiwangxin High-Tech Industrial Park, Songbai Road, Xili Street, Nanshan District, 518110 Shenzhen, P. R. China**

**Tel: +86-755-2643 3514**

**Fax: +86-755-2643 0930**

**E-mail: [info@creative-sz.com](mailto:info@creative-sz.com)**

**Website: [www.creative-sz.com](http://www.creative-sz.com)**



**EC-Representative: Shanghai International Holding Corp. GmbH (Europe)**

**Address: Eiffestrasse 80, 20537 Hamburg Germany**



**Etheria Medical Ltd**

**The Old Brush Factory Unit 2d Whickham Industrial Estate,  
Swalwell, Newcastle Upon Tyne, United Kingdom, NE16 3DA**

**Tel: +44-191-4889922**

**Fax: +44-191-4889922**